



Manufactured by Superior
with Solids 
SWR

DensFlow

Flow measurement
for densephase-conveying



Using

DensFlow is a measuring system especially developed for measuring the flow rate of conveyed solids in densephase.

DensFlow is used for the online-measuring of:

- all types of powder or granulates
- pneumatically densephase conveyed materials
- after mechanical conveying systems like chutes, slides or downpipes
- with large flow rates

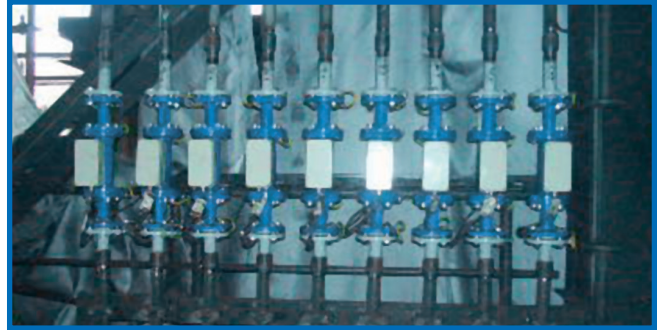

Function

In the measuring pipe a homogeneous field is produced by special linking of a high frequency, electromagnetic alternating field. Solids, which are within this measuring field, absorb the energy of this alternating field. This leads to a measuring signal according to the concentration of the conveyed material in the measuring pipe (lbs/ft³).

By means of the same sensor technology within the measuring tube on two known locations the change of the alternating field is measured. These two sensors have a defined distance.

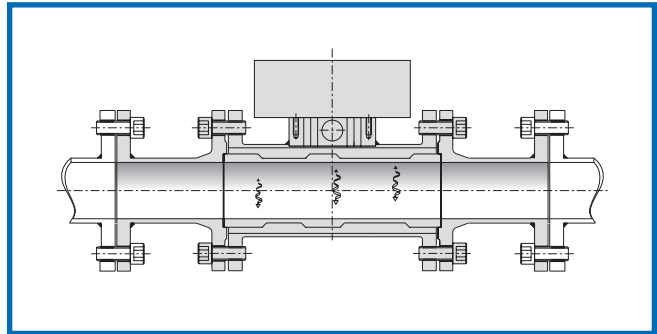

The transmitter with its integrated correlator determines the time of the conveyed material between the two sensors. With the known distance the velocity of the solids is then determined (ft/sec).

From the two measured values concentration (K) and velocity (V) as well as the known cross section (A) of the measuring pipe then the flow rate is determined according to: $Q = K \times V \times A$ and evaluated as a 4...20 mA-signal.

System

A complete measuring unit consists of the following components:

- Sensor (Measuring pipe) DMS 100 for installation into the pipe
- Transmitter DME 100

The transmitter is connected to the pipe by means of a 4-wired, shielded cable. The maximum distance between sensor and transmitter is 300 m.

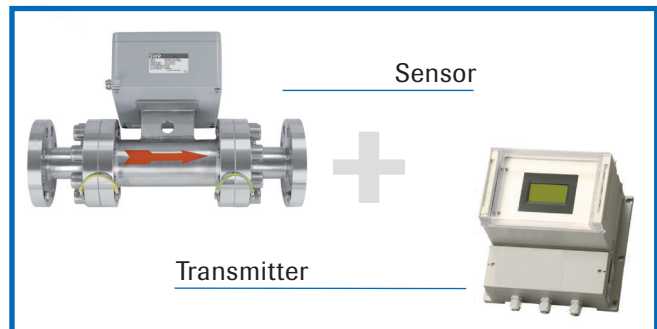

Applications – Practical Examples

Fuel conveying

At blast furnaces or combustion plants fuels are supplied in a densephase conveyed manner by several fuel lines to the combustion. Combustion is optimal and most efficient, if the flow rate is equal in all pipes. DensFlow measures the instantaneous mass flow in each single pipe, which then can be regulated by control valves.

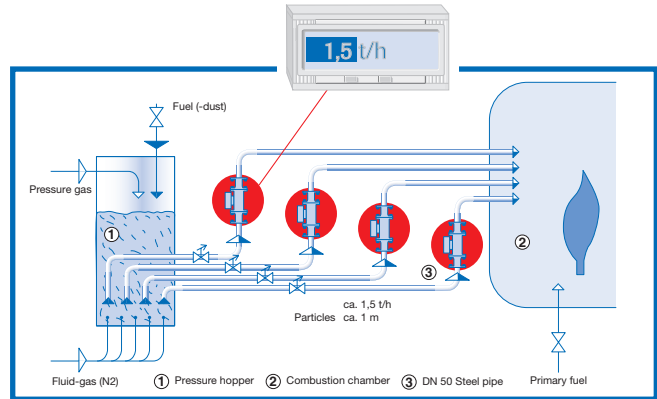

Careful conveying in densephase

Many solids, which are very expensive, are transported in a slow, careful densephase conveyed manner. DensFlow provides precious measured values for the velocity of the solids and the quantity in order to optimize the transport of solids.

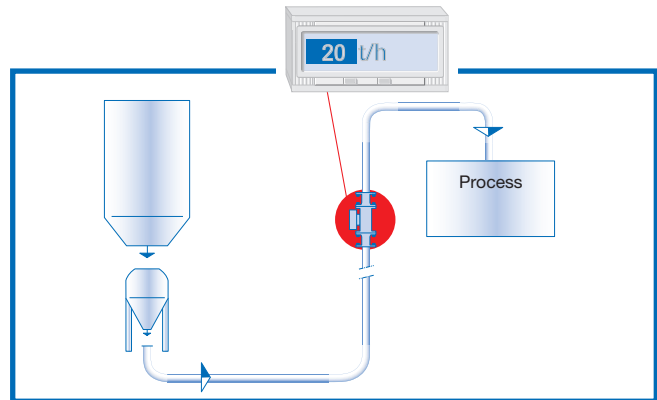

Benefits

- Installation is simple
- Accurate mass flow measurements
- Measurement independent of the material's velocity
- Easy retrofitting
- Maintenance free
- Measuring system without moving parts

Mounting and Installation

With pneumatically densephase conveyed materials, the fitting position will be determined according to the necessary inlet and outlet section.

When mounting the measuring system after mechanical conveyed feeders, there is usually no special inlet section necessary for the material flow is uniform* (*equal direction of the material flow, no turbulences or different flow directions of solid particles).

At the determined mounting position the measuring pipe will be fixed by means of a flange. Measuring pipes are available standard in nominal diameters from 0.4 inch up to 6 inch with flange connections according to EN 1092-1 or ANSI.

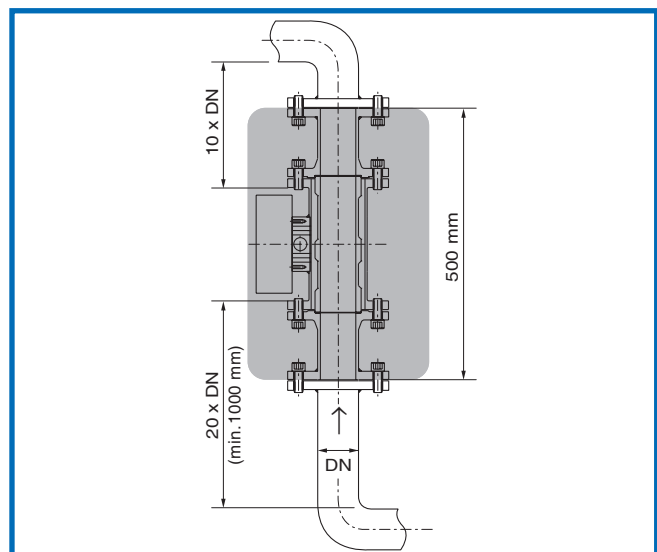

Technical Data

Sensor	
Housing	Steel St 52, powder-coated (optional Stainless steel 1.4571 DN 10...150 mm (bigger diameters on demand) Flange EN 1092-1 or ANSI
Inner pipe	Ceramic
Protection category	IP 65 (NEMA 4X)
Ambient temperature	Sensor electronic: 32 ... +140 °F
Mediums temperature	Sensor pipe: 32 ... +176 °F (higher temperatures as option)
Working pressure	Max. 16 bar, optional 25 bar
Working frequency	88 kHz
Weight	Depending on the nominal diameter
Velocity range	3.2...32.8 ft/s (optional 65ft/s)
Dimension	Ø DN + 5.9 in, L 19.68 in
Accuracy	± 2...5 % in calibrated range

Transmitter	
Power supply	110 / 240 V AC, 50 Hz, 24 V DC
Power consumption	20 W / 24 VA
Protection category	IP 65 to EN 60 529/10.91 (NEMA 4X)
Operating temperature	-10 ... +45 °C [14 ... 113 °F]
Dimensions	258 x 237 x 174 mm (W x H x D)
Weight	Approx. 5.5 lbs
Cable glands	3 x M16 (4.5-10 mm Ø)
Terminal clamp wire size	0.2-2.5 mm ² [AWG 24-14]
Current output signal	2 x 4 ... 20 mA (0 ...20 mA), load < 500 Ω
Alarm output Error output	Relay with toggle switch - max. 250 V AC, 1 A
Data backup	Flash memory
Impulse output	Open collector - max. 30 V, 20 mA
RS 485 interface	ModBus RTU