



3DLevelScanner™ II
3DLevelScanner™ II HT

Installation Manual



3D Model S

Diameters to 16' and Heights to 230'
No PC software.

3D Model M

Diameters to 49' and Heights to 230'
Software reads continuous volume on remote screens.

3D Model MV

Diameters to 49' and Heights to 230'
Software gives 3D representation of contents.

3D Model MVL

Diameters to 49' and Heights to 230'
Multiple MV's with 3D software.



Contents

| | | |
|----------|--|-----------|
| 1 | ABOUT THIS DOCUMENT | 3 |
| 1.1 | SYMBOLS IN USE | 3 |
| 1.2 | FOR YOUR SAFETY | 3 |
| 1.3 | STORAGE AND TRANSPORT | 4 |
| 2 | 3DLEVELSCANNER^M OVERVIEW | 5 |
| 2.1 | THEORY OF OPERATION | 5 |
| 2.2 | WIDE APPLICATION RANGE | 5 |
| 2.3 | ADVANTAGES | 5 |
| 2.4 | MODELS | 6 |
| 3 | PHYSICAL INSTALLATION | 7 |
| 3.1 | LOCATION AND POSITIONING GUIDELINES | 7 |
| 3.2 | SCANNER ORIENTATION | 9 |
| 3.3 | SITE PREPARATIONS | 10 |
| 3.4 | ASSEMBLY AND MOUNTING | 11 |
| 3.5 | WIRING | 14 |
| 4 | FIRST-TIME ACTIVATION | 18 |
| 4.1 | LOCAL USER INTERFACE | 18 |
| 4.2 | SWITCHING ON THE SCANNER | 19 |
| 4.3 | FIRST-TIME ACTIVATION STEPS SUMMARY | 20 |
| 4.4 | INITIAL SETUP PROCEDURE | 20 |
| 5 | DIFFERENT CONNECTION METHODS | 21 |
| 5.1 | 4-20mA CONNECTION | 21 |
| 5.2 | HART COMMUNICATION | 21 |
| 5.3 | RS485 COMMUNICATION | 22 |
| 5.4 | COMMUNICATION USING THE 3DLINKPRO | 22 |
| 5.5 | TCP/IP COMMUNICATION | 22 |
| | APPENDIX A: ONBOARD CONFIGURATION | 23 |

| | |
|---|-----------|
| OUTPUT SETTINGS..... | 23 |
| DISPLAY SETTINGS..... | 25 |
| DEVICE INFO..... | 26 |
| DEVICE RESET..... | 27 |
| APPENDIX B: ACCESSORIES..... | 28 |
| INSTALLATION FLANGES..... | 28 |
| NECK EXTENSIONS..... | 30 |
| HEAD-BODY SEPARATION..... | 31 |
| CABLE GLANDS..... | 32 |
| APPENDIX C: MAINTENANCE..... | 33 |
| APPENDIX D: RECOMMENDED TOOLS..... | 34 |
| APPENDIX E: SPECIFICATIONS..... | 35 |
| TECHNICAL DATA..... | 35 |
| DIMENSIONS..... | 38 |
| APPENDIX F: RMA PROCEDURE..... | 40 |
| RETURN MATERIAL AUTHORIZATION POLICY..... | 40 |
| APPENDIX G: STANDARDS & APPROVALS..... | 42 |



GTS, Inc.
 PO Box 799, Shalimar, FL 32579
 Phone: 850-651-3388
 Fax: 850-651-4777
 Email: info@onthelevel.com
 Website: www.onthelevel.com

1 About this Document

This operation manual provides detailed product related information, installation, setup and operation instructions for 3DLevelScanner models S, M and MV. The manual is designed for trained personnel. Please read it entirely and carefully before unpacking and installation of the products.

1.1 Symbols in use

The following symbols indicate different sections of additional information as follows:



IMPORTANT: An indication for additional information, tips, hints or an indication of helpful additional knowledge.



WARNING: Indication of a potentially dangerous situation, which could result in serious injury to persons and/or damage to the 3DLevelScanner.



EX APPLICATION: An indication of special instructions relevant to installations

1.2 For your safety

Authorized personnel

All operations described in this manual must be carried out by authorized, trained personnel only. For safety and warranty reasons, any internal work on the scanners must be carried out by manufacturer-authorized personnel only.

Warning about misuse

Inappropriate or incorrect use of the scanner may result in hazards and application-specific malfunctioning such as vessels overflow or damage to system components through incorrect mounting or adjustments.

If the 3DLevelScanner is used in a manner not specified in this manual, the protection provided by the 3DLevelScanner will be impaired.

General safety instructions

The 3DLevelScanner is a high-tech device requiring strict observance of standard regulations and guidelines. The user must strictly follow the safety instructions in this operating manual. Local and national electrical codes and all common safety regulations and accident prevention rules should be considered during installation as well.

CE conformity

The 3DLevelScanner conforms to CE's EMC and NSR standards. CE conformity is as follows:

| | |
|---------------------------|---|
| EMC | <ul style="list-style-type: none">• EN 61326-1: 2006• CISPR 11: 2003 Class A• IEC 61000-4-2: 2001 Air Discharge, 8kV• IEC 61000-4-3: 2002 80-1000MHz, 1V/m; 1.4-2GHz, 1V.m; 2.0-2.7GHz, 1V/m• IEC 61000-4-4: 2004 Power Lines: 1kV; Signal Lines: 0.5kV• IEC 61000-4-6: 2004 0.15-80MHz 1VRMS, 80% A.M. by 1kHz Power & Signal Lines |
| NSR (73/23/EWG) | <ul style="list-style-type: none">• EN 61010-1: 2001 |

FCC conformity (EMC)

FCC Part 15, Sub-part B, Class A.

Safety information for Ex Areas



EX-AREAS: Please note the Ex-specific safety information for installation and operation in Ex areas. These safety instructions are part of the operating instructions manual that comes with Ex-approved scanners.



WARNING: Substitution of components may impair intrinsic Safety.

WARNING: For preventing ignition of flammable or combustible atmospheres, read, understand and adhere to the manufacturer's live maintenance procedures.

1.3 Storage and transport

The scanner is protected by special packaging during transport, and is guaranteed to handle normal loads during transport.

2 3DLevelScanner™ Overview

2.1 Theory of Operation

The GTS 3DLevelScanner™ is the only device available which delivers accurate measurement of bulk solids and powders – regardless of material type, product characteristics, storage silo type, size, bin or container, and harshness of the storage environment. The product incorporates GTS unique dust-penetrating technology to achieve an unrivalled degree of process measurement and inventory control.

The 3DLevelScanner™ includes an array of three antennas that generate low frequency acoustic signals and receive echo signals from the contents of the silo, bin, or other container type. Using these antennas, the unit measures not only the time/distance of each echoed signal but also its direction.

The built-in Digital Signal Processor digitally samples and analyses the echoed signals and produces accurate measurements of the level, volume, and mass of the stored contents, and generates a 3D representation of the position and form of the material within the container for displaying on remote computer screens.

2.2 Wide Application Range

The 3DLevelScanner™ measures practically any kind of solid material, stored in variety of containers, including large open bins, bulk solid storage rooms, stockpiles and warehouses, mapping loads that randomly form over time inside silos, and many other challenging applications that were not possible until now. The sensor can measure ranges of up to 10m (230ft) and generate 3D mapping of the material surface.

2.3 Advantages

- **Service and maintenance-friendly** - Non-contact measuring principles, the 3DLevelScanner™ is highly easy to service and maintain
- The only available device for solid volume measurement applications
- The only available device that measures minimum and maximum levels
- Suitable for measuring all solid materials (including ones with low dielectric constants)
- Operates in dusty and moisture environments
- Profiles of adhesions of materials to vessel walls
- Self-cleaning antenna

- 3-Dimensional mapping visualization tool for filling-point choosing assistance (in vessels with multiple filling points)
- The most reliable sensor available - includes 3 transmitters and 3 receivers

2.4 Models

The 3DLevelScanner™ line of products is consisted of three models: **S**, **M** and **MV**.

Model S

The S model determines the average level of the stored contents and average distance from the scanner to the surface of the material. Based on a 300 beam angle, The S model is ideal for small and narrow vessels of up to 4m (13ft) in diameter.

Model M

The M model yields highly accurate readings of level and volume. It is appropriate for large vessels of up to 15m (50ft) in diameter and at least twice as high (30m | 100ft), open bins and stockpiles. It is based on a 100 beam angle. The M model also presents the minimum and maximum Level/Distance measurements along with the calculated average.

Model MV

The MV model is identical to the M model, with the additional capability of generating a 3-dimensional representation of the stored contents on a remote computer. This feature is highly useful for mapping build-up loads that form randomly over time and other irregularities.

All three models are available in various modes, such as ATEX approved, FM approved, and non-ATEX (for more information, see Approvals on page 31) and also available with neck extension (see *Appendix B: Accessories: Neck on page 30*) and compatible with the Head-Body separation kit.

Each of the models is available in two temperature ranges:

3DLevelScanner II is compatible in applications where the maximal temperature in the surroundings inside the vessel is up to 850C (1850F).

3DLevelScanner II HT is compatible in applications where the maximal temperature in the surroundings inside the vessel is up to 1200C (2480F).

All references in this manual to the 3DLevelScanner can be referred to as 3DLevelScanner or simply the scanner, if nothing else is mentioned it applies to any of the scanner's models.

3 Physical Installation

This chapter describes the necessary steps for proper installation of the 3DLevelScanner beginning with important pre-installation considerations such as environmental conditions, correct positioning and orientation, through the mounting and configuration process.

3.1 Location and positioning guidelines

Choosing the proper location to the 3DLevelScanner™ should consider every aspect of the vessel and contained materials, including the silo or vessel dimensions, type of material and angle of repose, locations of filling and emptying points, maximum level of material, internal construction and moving part and any other consideration which may possibly affect the scanner performance. GTS strongly recommends installing the 3DLevelScanner according to the 3DScanner Locator PC software for properly choosing installation location and positioning. In case of no satisfying software solution, please contact GTS Customer Support for assistance with the positioning.

Moisture and water condensation

 Use the recommended cable gland and tighten the cable connection. For additional protection against moisture, lead the connection cable downward in front of the cable entry. Rain and condensation water can thus drain off. This applies mainly to mounting in areas where moisture is expected (e.g., by cleaning processes), or on cooled or heated vessels.

Measuring range

The measuring range is set in the scanner and defined by silo dimensions and the full and empty calibration levels. These levels set the 100% and 0% values relatively.

The scanner measurements are calibrated to the top of the body. If the scanner is lowered, or mounted with neck extension or head-body separation, it is important to adjust all measurements to the top of the body.

 **Note:** If the material level reaches the antenna, build up could form inside the horn over time and cause measurement errors or damage to the membranes.

Note: the 3DLevelScanner™ has a 500mm (20") of dead zone (or blanking zone).

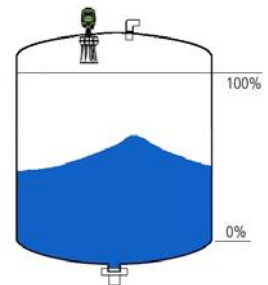

Pressure

The process fitting must be sealed in the case of a low pressured vessel. Before usage, verify that the sealing material is resistant to the stored medium. The maximum allowed pressure (stated in *page 35: Appendix E: Specifications*) is indicated on the type label of the sensor.

Installation location

Choosing the proper installation location for the 3DLevelScanner is an important part of the installation process. A Wrong location may result in erroneous measurements or loss of performance.

The usage of the 3DScanner Locator Software is recommended for finding the optimal location, which is based on various parameters.

The following factors must be taken into consideration while choosing the installation position: vessel dimensions, filling and emptying point locations, internal structure or support and other restrictions related to vicinity to noisy devices (such as electrical motor) and any other element which may affect the proper operation of the scanner.



IMPORTANT: When mounting the 3DLevelScanner, do not install the scanner near the vessel wall. The installation must consider the vessel dimensions. Installing the scanner near the side wall will result in bad performance and will not be supported by GTS.

Installing the 3DLevelscanner at the center of the vessel is not recommended, since the perfect symmetry from all sides toward the scanner may affect the echoes distinction.

- The scanner cannot be mounted at a distance lower than 500mm (20") from the wall.
- When choosing the installation location, consider the filling and emptying points.
- Use the 3D Scanner Locator PC software for choosing a proper location.

3.2 Scanner Orientation

Mounting direction

Mounting of the 3DLevelScanner at a specific direction is important. The ridge on the horn body, and the notch on the top of the thread (representing antenna no.1) should be directed toward the center of the vessel.

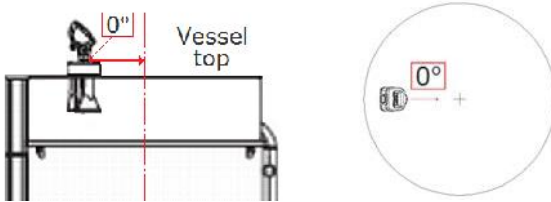

Mounting direction. 0° indication toward vessel center

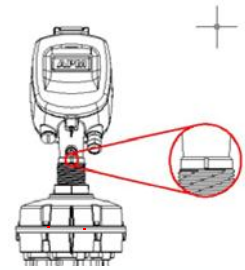

The 0° Label Location

Standpipe mounting

When mounting the scanner using a standpipe part it should be assembled and positioned at a height that leaves at least 10mm (0.4") out of the standpipe, for the antenna end protrudes, as shown in the figure to the right.

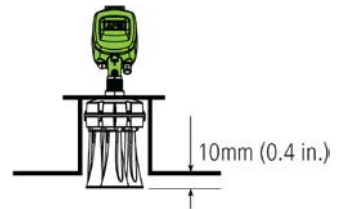

IMPORTANT: Any obstruction as well as rails, frames or support beams should never interfere with the acoustic beam transmitted and received, as shown in the figure to the right.

This comment applies to all 3DLevelScanner models including S model.

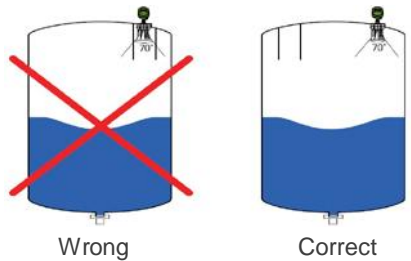

Inflowing material

Do not mount the scanners in or above the filling stream, not too far from the stream, and not in the direction of the filling stream in case it is diagonal, to avoid damage to the scanner from the flowing material. The scanner should be located with a clear line of sight to the top of the material at high levels, not to be affected by the filling stream or the noise it creates.



Fitting

The fitting area should be prepared to maintain the horns/antennas vertically positioned to the ground, as shown in the figure.

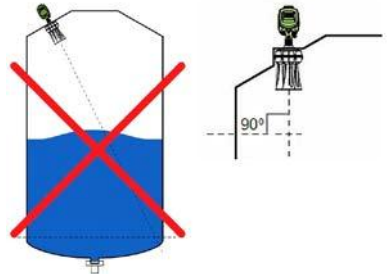

Wrong

Correct

3.3 Site Preparations



IMPORTANT: The site preparations described in this section must be complete and verified prior to installation. For optimal installation, ensure that the 3DLevelScanner can be positioned and fitted according to the guidelines described in the beginning of this chapter.

For a list of items recommended to prepare before installing the 3DLevelScanner, refer to *page 34: Appendix D: Recommended Tools*.

Before installing, make sure the following preparations have been completed.

Power

- Connecting the 3DLevelScanner chassis to the facility grounding is important for protection.
- A 24VDC (1.5 Watt) power supply must be prepared and ready to use near the scanner mounting location.
- The 3DLevelScanner is a 4-Wire device. The voltage supply and data output (4-20mA) are carried along two separated two-wire connection cables.

Communications

- Route communication cables in proper conduits and use a proper cable type.
- The cable used for RS-485 should be of twisted-pair type, shielded, with 120 Ohm impedance and approved for RS-485 communications.
- The cable used for 4-20mA should be rated for analog signals, twisted-pair, low resistance and shielded.

3.4 Assembly and Mounting

Package Contents

The supplied package includes:

- 3DLevelScanner sensor
- Documentation
- CD with the 3DLevel Manager software and marketing materials
- Cable glands accessory kit
- Ex-specific safety instructions (with Ex versions)
- Certificates if applicable

Included components

The 3DLevelScanner includes the following components:



3DLevelScanner Body



3DLevelScanner Head

- 3DLevelScanner Body: Includes three antennas, transducers and temperature sensor. The flange is mounted on the body and tightened to it.
- 3DLevelScanner Head: Includes the electronic board with LCD display and all wiring connections. The Head is mounted on the body.

Flange preparation

Prior to the installation of the 3DLevelScanner, an installation flange should be prepared. The flange must have a 52mm (2.05") hole for the scanner body thread insertion.

GTS provides two types of standard flanges. Please refer to *page 28: Appendix B: Accessories* for flange specifications.



Installing the Flange

- 1 Verify existence of the O-Ring on the neck tube remains in place as shown:



- 2 Use an adjustable 18" wrench to untighten and remove the nut from the neck tube.



- 3 Place flange over the neck tube, insert until placed as shown:

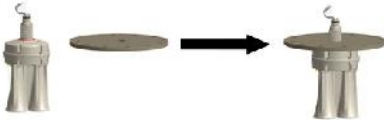

- 4 Replace the nut and tighten it over the neck tube to the flange, using an adjustable 18" wrench.

Make sure the scanner is well tightened to the flange, for vibrations prevention and proper sealing.

When mounting the scanner body and flange to the silo standpipe make sure the scanner is facing the center of the silo as described in *Scanner Orientation on page 9*.



Installing the Scanner Head

- 1 Unpack the scanner head.
Untighten the four screws of the housing rear panel using a 4mm hex key, and remove the rear panel. The screws are of captive type and will not fall off.



- 2 Remove the cable clamp located at the bottom inside the scanner as shown.



- 3 **Gently** insert the antenna cable through the scanner head. Make sure not to damage the (white) cable connector. This connector connects the transmission signal from the electronic board to the transducers. Damage to the connector or to the wires will result with malfunctioning operation of the scanner.

- 4 Insert the scanner head onto the neck tube.



IMPORTANT:

When inserting the scanner head onto the neck tube, make sure to push the head all the way down until it fully contacts the top of the neck tube.

Note: It is recommended to lubricate the O-Ring on the neck tube prior to installing the scanner head. This makes it easier to insert and properly locate the scanner head over the tube neck.

Note: The 3DLevelScanner head may be installed in six different positions.

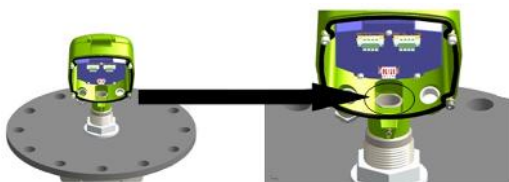

- 5 Tighten the front screw using a 4mm hex key and a 13mm wrench.



- 6 Replace the cable clamp back to position, between the antenna cable and the electronic board.



- 7 **Carefully** connect the antenna cable connector back to the electronic board as shown.

This connector allows the transmission signal from the electronic board to the transducers. Damaged connector or wires will result with malfunctioning operation of the scanner.



- 8 Leave the scanner open at this stage in order to complete the wiring.

3.5 Wiring

The 3DLevelScanner can be connected in different modes and configurations for different external systems such as PLC or DCS and communications on RS485, ModBus, and HART and also to RS485 bus converting adapters to communication gateways such as 3DLinkPro for GMS or GPRS data relay and TCP/IP gateway. For in-depth details and explanations on wiring and communication, refer to *page 21: Different Connection Methods*.

- Use 8-13mm (20-24 AWG) diameter cables to ensure proper and effective sealing of the cable gland entry opening.
- Select a cable suitable for application (indoor or outdoor) and safety certified according to national regulations.

Communications



Note: If electromagnetic interference is expected, usage of a screened and twisted wired cable is recommended for the signal lines, which should be connected to the ground reference.



CAUTION: Always observe the following safety instructions:

Connections must be made only in the complete absence of line voltage.

If over-voltage is expected, overvoltage arresters should be installed.

Use only a safety-certified power supply with dual insulation between the primary and output for powering the unit. The power supply output rating must be limited to 20-32VDC, 1A for a single 3DLevelScanner device, and not to be connected to a DC distribution network.



In hazardous areas you should take note of the appropriate regulations, conformity and type of approval certificates of the sensors and power supply units. Refer to the printed safety manual provided with the ATEX/FM approved 3DLevelScanner.

Power Supply

For power supply specifications, refer to *page 36: Appendix E: Specifications* for full details.

4...20 mA/HART 4-wire: The power supply and signal current inputs must be carried over two separated pairs.

Connection Procedure

- 1 Untighten the four screws of the scanner housing rear panel and remove the rear panel. The screws are of captive type and will not fall off.



- 2 Loosen the compression nut of the cable gland entry.

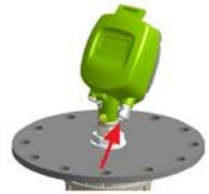

- 3 Insert the cable into the scanner through the cable gland and entry opening.

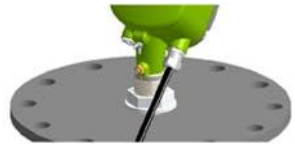

- 4 Remove approximately 10cm (4 inches) of the cable mantle and strip approximately 1cm (0.4 inches) the edge of each conductor.

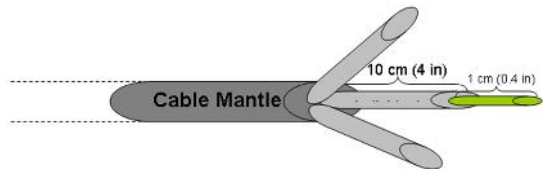

- 5 Open the terminal block screws located inside the scanner housing using a thin flat (A3/32") screwdriver. Insert the wire edges into the terminals according to the wiring plan detailed next, and fasten the terminal screws. Gently pull the wires to ensure they are securely connected.

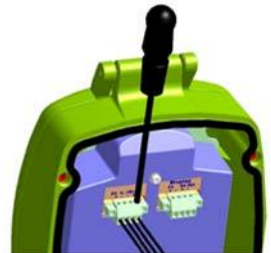

6 Terminal block wiring plan.

The tables below describe the connections.

Refer to the following Local Connection and Multi-Drop Connection drawings for details.

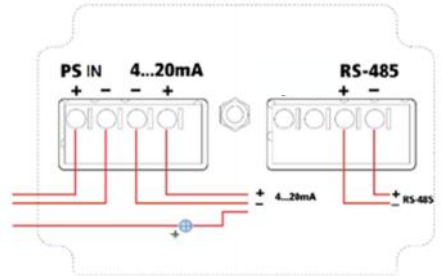

| Left Connector | |
|-----------------|---|
| Ports | Description |
| PS IN + - | Feed in power supply 20 - 32 VDC |
| 4...20mA - + | 4 - 20mA HART Communications terminals |

| Right Connector | |
|-----------------|--|
| Ports | Description |
| RS-485 + - | RS-485 Modbus RTU Communications terminals |

7 Connect the external ground terminal with potential equalization to the external ground terminal of the scanner, located as shown.

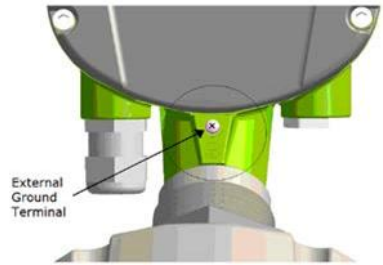

An internal cable grounding connection is also possible using the inner connection as shown.



8 Tighten the compression nut over the cable gland entry opening. Verify that the sealing ring completely wraps the cable.



IMPORTANT: Gland compression nut tightening provides good sealing. It is necessary for the scanner to maintain IP61 requirements, and for extended scanner lifetime.

- 9 Attach the rear panel back to position at the rear of the scanner housing and tighten the four screws to secure it in place, using a 4mm hex key.

The 3DLevelScanner is ready for configuration.



IMPORTANT: Use direct connection between the scanners and the plant (PLC/SCADA).

IMPORTANT: For a remote connection, use the 3DLinkPro remote connection module or a local PC/Laptop computer as detailed in the following



The 3DLevelScanner is not a loop powered device but a 4W device.

WARNING: The 4...20mA | HART lines should NOT be connected using multidrop.

4 First-Time Activation

4.1 Local User Interface

Configuration and adjustment of the 3DLevelScanner must be done using the 3DLevelManager software, with the optional addition of GSM/GPRS communications using 3DLinkPro. For detailed configuration procedure, refer to *GTS 3DLevelManager Software Manual* and the *3DLinkPro Manual*.

The 3DLevelScanner User Interface

The user interface includes a 4-lines LCD display and the four keys located on the front side of the device, marked ESC, +, - and E.

Key functions are as follows:

- ESC** Navigates back within a function menu.
Continuous 3 second press exits to the default screen.
- +** Navigates upwards in the navigation list.
Navigates right within a function.
- Navigates downwards in the navigation list.
Navigates left within a function.
- E** Navigates to the right when within a function group.
Stores a value once configured.



The following, simultaneous key-press combinations perform special functions as follows:

- + E** Increases | decreases the LCD display intensity.
- E** Press and hold the **E** button, then use the **+** or **-** buttons to increase or decrease the intensity of the display.

Operating menu

The operating menu consists of two levels:

- **Function groups:** The scanner functions are organized groups. Available function groups are: Output Settings, Display Settings, Device Info and Device Reset.
- **Functions:** Each function group consists of one or more functions. The functions may perform different actions or modify scanner setting parameters. Numerical values can be entered, and parameters can be selected and saved.

4.2 Switching on the scanner

Once the 3DLevelScanner is connected to the power supply and switched on, it initializes a self-test which lasts for approximately 30 seconds. When the initialization is complete, the following content is displayed allowing selecting a language and distance units:

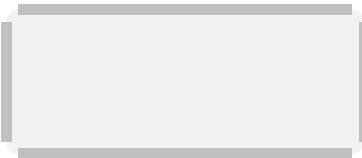
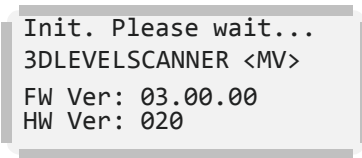
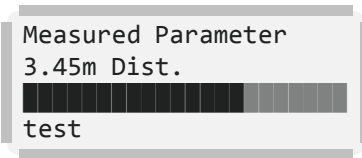
| | |
|--|---|
| <p>1 The unit is turned on and is initializing for about 30 seconds, during which the display remains blank.</p> |  |
| <p>2 The version screen appears: The value in <> describes the scanner model: S, M, MV or MVL. FW Ver: Firmware version HW Ver: Hardware version</p> |  |
| <p>3 Once the startup process is complete, the following screen appears showing the current distance measurement. The forth line displays the scanner tag name. By default, when the name has not been configured yet, this line remains empty. Press E to return to the Main Menu. Press ESC for 3 seconds to switch to the basic measurement screen.</p> |  |

4.3 First-time Activation Steps Summary

Here is a list of all the actions taken during the first-time activation of the scanner:

- 1 Connect power to the scanner. Following about 30 seconds duration, the version screen appears.
- 2 After a little while, the display switches to the current distance measurement screen.
- 3 Press **[C]** to enter the Main Menu.
- 4 In the Main Menu, choose Output Settings, by pressing **[C]**, and set the polling address.

Following completion of the first-time activation tasks, use the 3DLevelManager software to establish the connection and to make all the necessary configurations.

4.4 Initial Setup procedure

Setting the scanner address

The sensor address setting is mandatory when multiple sensors are connected over a RS485-Multidrop (Daisy Chain). Addresses must be set prior to parameter adjustment.

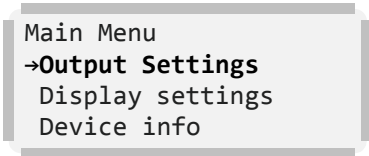
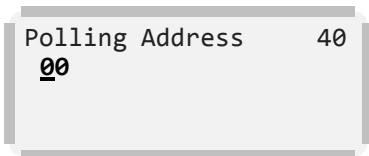
| | |
|--|--|
| <p>1 At the Main Menu, scroll down to Output Settings option using the [C] key and press [C] to switch to the Polling Address configuration screen.</p> |  <p>Main Menu →Output Settings Display settings Device info</p> |
| <p>2 Use the [C] key to switch between the two digits. Use the [C] key to modify the value. The default polling address is 00. The polling address ranges from 00 to 63. Press [C] to store the modified address.</p> |  <p>Polling Address 40 <u>00</u></p> |

5 Different Connection Methods

Using the 3DLevelManager for communicating with the 3DLevelScanner allows the user to choose several communication types: RS485, HART, GSM, GPRS and TCP/IP, for more information and details regarding the communications, refer to the *GTS 3DLevelManger Software Instructions manual*.

5.1 4-20mA Connection

The 3DLevelScanner outputs the % of Volume as set in the configuration and between the Full and Empty calibration levels. The 4-20mA current output is available through ports 3 and 4 of the left green connector (as shown in the drawing to the right). Ports 3 and 4 are the negative and positive poles, respectively.

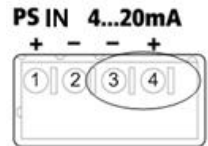

The 4...20mA line is connected directly from the scanner mounted on the vessel to the PLC/DCS/Display or any other device (as shown below).

IMPORTANT: This type of connection is active and not passive, hence the 3DLevelScanner is the active module and the PLC should be the passive module.

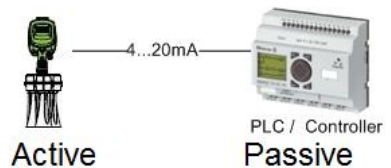

5.2 HART Communication

The 3DLevelScanner supports HART protocol over the 4-20mA wires. By connecting a 250 Ohm resistor on one of the wires and a HART modem and communication to and from the scanner can be established from the 3DLevelManager software.

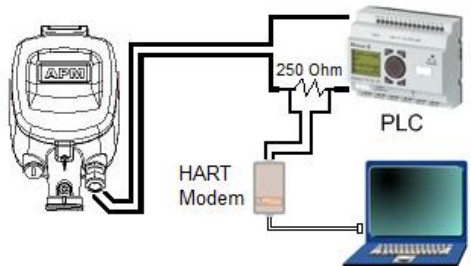

5.3 RS485 Communication

The 3DLevelScanner includes an RS485 communication port. This type of connection allows a computer to communicate with the scanner. It also allows a multiple scanner connection on the same RS485 bus and communication with all scanners using a single connection to the computer running the software.

In both single or multi scanner connection, it is required to use an appropriate cable rated for RS485, the cable should be of twisted pair, has 120 Ohm impedance and shielded. The total length of the cable should not reach 1000m (3280ft).

In case of a multi scanner connection, all scanners must be connected in parallel mode in the RS485 ports. Hence, all the + (positive) ports of the RS485 should commonly be connected and all the - (negative) ports of the RS485 should be connected commonly. The connection must be of Daisy-Chain type and have at each of the far ends of the chain 120 Ohm resistor (such resistor is provided with the scanner).

Each Scanner must be configured with a different polling address.

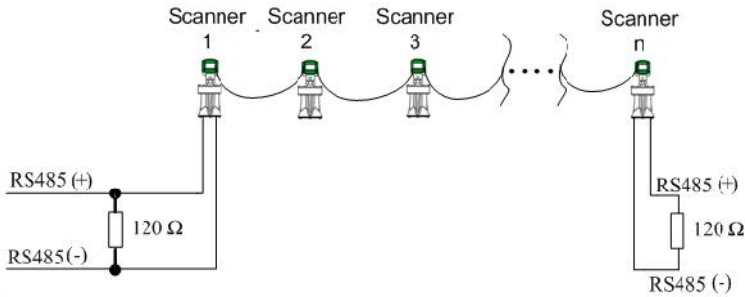

5.4 Communication using the 3DLinkPro

In both single and multiple scanner installation, the 3DLevelScanner can be connected to a GSM/GPRS modem in order to transfer the data over the cellular network. The 3DLinkPro should be connected on the RS485 bus as any of the scanners, including cable and resistors as needed. For further details on wiring and establishing a connection, refer to the *GTS 3DLinkPro manual* and to the *3DLevelManager Software Instructions manual*.



Note: In such communication mode, only one computer running the 3DLevelManager software can be connected to the scanners.

5.5 TCP/IP Communication



The RS485 bus can be converted to TCP/IP communication. TCP/IP to RS485 converter installation should be done as with any scanner, including the resistors and daisy-chain considerations.



Note: Consult with GTS Technical Support team for assistance on the proper TCP/IP converter to use.

Appendix A: Onboard Configuration

Output Settings

This function defines the scanner Polling Address, and further to Measured Parameter settings. Navigate down at the Main Menu screen using the  key, select the **Output Settings** option and press  to enter the Output settings menu.



The first screen of Output Settings allows setting the scanner polling address.

Select the proper **Polling Address** using the  |  keys, and press  to proceed.

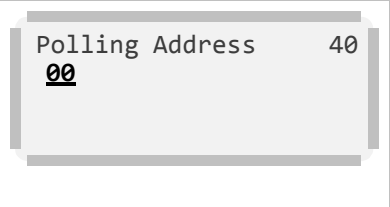
Exiting this menu automatically switches to the Measured Params. menu.



The following functions set displayed measurement units for Distance, Level, Volume, Temperature and their maximum allowed values. As well, it allows reading the current measurements for Analog Output, SNR and Temperature. This menu is not accessible from the main menu. It will appear following completion of the Output Settings or the Display Settings menus.



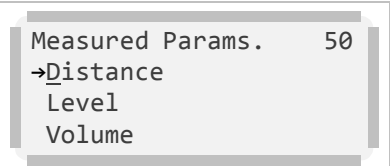





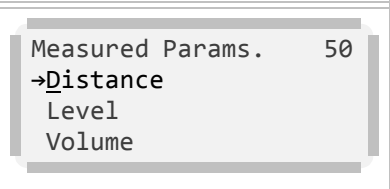



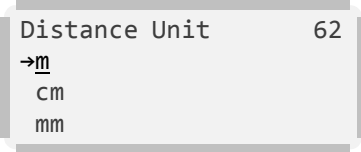

Navigate up/down the menu using the  |  keys, and Press  to select the desired option.

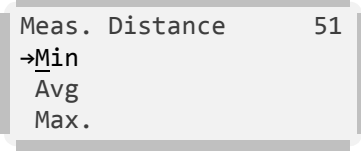

1 Measurement Distance settings

Select the **Distance** option and press  to proceed.

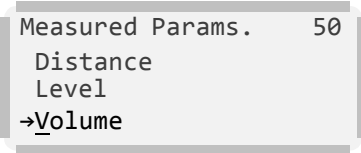
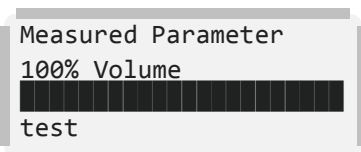

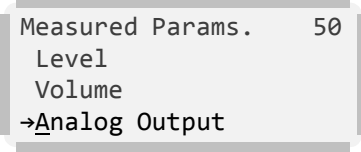
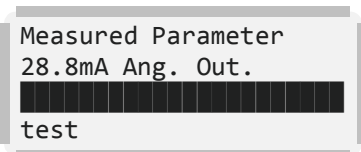
| | |
|---|--|
| <p>2 Select the desired Distance Unit using the   keys, and press  to store the option and proceed.</p> |  <p>Distance Unit 62 →<u>m</u> cm mm</p> |
| <p>3 This menu defines how the Measured Distance is displayed: by a minimum value, a maximum value or an average value. Select the desired option using the   keys. Press  to store and proceed.</p> |  <p>Meas. Distance 51 →<u>Min</u> Avg Max.</p> |
| <p>4 Measurement Level settings This menu defines how the Measured Level is displayed: by a minimum value, a maximum value or an average value. Select the desired Meas. Level option using the   keys. Press  to store and proceed.</p> |  <p>Meas. Level 52 →<u>Min</u> Avg Max.</p> |
| <p>Measurement Volume Select the Volume option from the Measured Params. Menu. Press  to proceed.</p> <p>The Measured Parameter screen is shown, displaying the Volume percentage.</p> |  <p>Measured Params. 50 Distance Level →<u>Volume</u></p>  <p>Measured Parameter 100% Volume ████████████████████ test</p> |
| <p>Analog Output Select the Analog Output option from the Measured Params. Menu. Press  to proceed.</p> <p>The Measured Parameter screen is shown, displaying the Analog Output value in mA.</p> |  <p>Measured Params. 50 Level Volume →<u>Analog Output</u></p>  <p>Measured Parameter 28.8mA Ang. Out. ████████████████████ test</p> |

SNR

Select the **SNR** option from the Measured Params. Menu. Press  to proceed.

The Measured Parameter screen is shown, displaying the SNR value in dB.

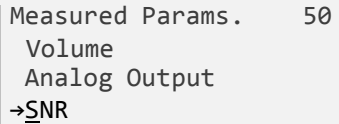

```

Measured Params.    50
Volume
Analog Output
->SNR
  
```

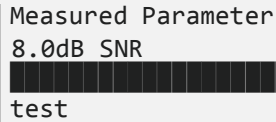



```

Measured Parameter
8.0dB SNR
████████████████████
test
  
```

Temperature

Select the **Temperature** option from the Measured Params. Menu. Press  to proceed.

Select the desired temperature measurement units using the  |  keys, and press  to store and proceed.

The Measured Parameter screen is shown, displaying the measured temperature value using the selected units.

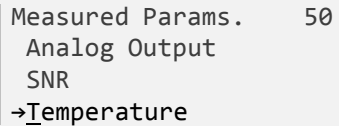

```

Measured Params.    50
Analog Output
SNR
->Temperature
  
```

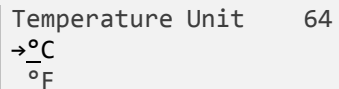

```

Temperature Unit    64
->°C
  °F
  
```

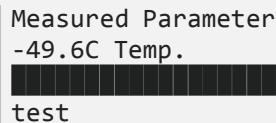



```

Measured Parameter
-49.6C Temp.
████████████████████
test
  
```

Display Settings

This function allows setting a Tag Name for the current scanner.

At the Main Menu, navigate down using the  key to select **Display Settings**, and Press  to proceed.

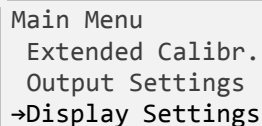

```

Main Menu
Extended Calibr.
Output Settings
->Display Settings
  
```

Set the Tag name for the current scanner. Switch between the digits using the **[]** key and modify the selected digit using the **[+]** keys. Press **[E]** to store the option. The display will switch to the Measured Params menu.

Tag Name 60
test

Device Info

This function allows setting a Tag Name for the current scanner.

At the Main Menu, navigate down using the **[]** key to select **Display Settings**, and Press **[E]** to proceed.

Main Menu
Output Settings
Display Settings
→Device Info

- 1 The screen displays the scanner Serial Number. This is a read-only identifier which is unique to each scanner.
Press **[E]** to proceed.

Serial Number 70
709001234

- 2 The screen displays the Software Version of the scanner.
Press **[E]** to proceed.

Software Version 71
03.00.37

- 3 The screen displays the Firmware Version of the scanner.
Press **[E]** to proceed.

Firmware Version 72
020

- 4 The screen displays the Hardware communications interface information for the scanner.
Press **[E]** to proceed.

HW Interface 73
4...28mA/HART
Modbus
RS485

- 5 The screen displays the Device Type: S, M or MV.
Press **[C]** to exit and switch back to the Main Menu.

```
Device Type      74
3DLevelScanner <MV>
```

Device Reset

This function allows selection of different reset options: Reset, Reset to Factory settings and Reset to Lab settings. Use with caution!

At the Main Menu, navigate down using the **[C]** key to select **Device Reset**, and Press **[C]** to proceed.

```
Main Menu
Display Settings
Device Info
->Device Reset
```

- 1 The Reset menu allows selection of the required Reset option.
The **Reset** option brings the scanner to power-up mode and clears measurements.
The **Reset to Factory** option will reset all parameters to their default values as well as performing the **Reset** option.
The **Reset to Lab** option is password protected and reserved for factory use.
Select the desired Reset option using the **[C]** key and press **[C]** to proceed.

```
Reset      80
->Reset
Reset to Factory
Reset to Lab
```

- 2 On selecting Reset or Reset to Factory, a confirmation request screen appears.
Select **Yes?** to proceed with the reset and restart process, or **No?** to cancel reset.
Press **[C]** to proceed and go back to the main menu.

```
Reset the device?  81
->Yes?
No?
```

Appendix B: Accessories

Installation flanges

The following flanges are available from GTS.

Flange type DN200

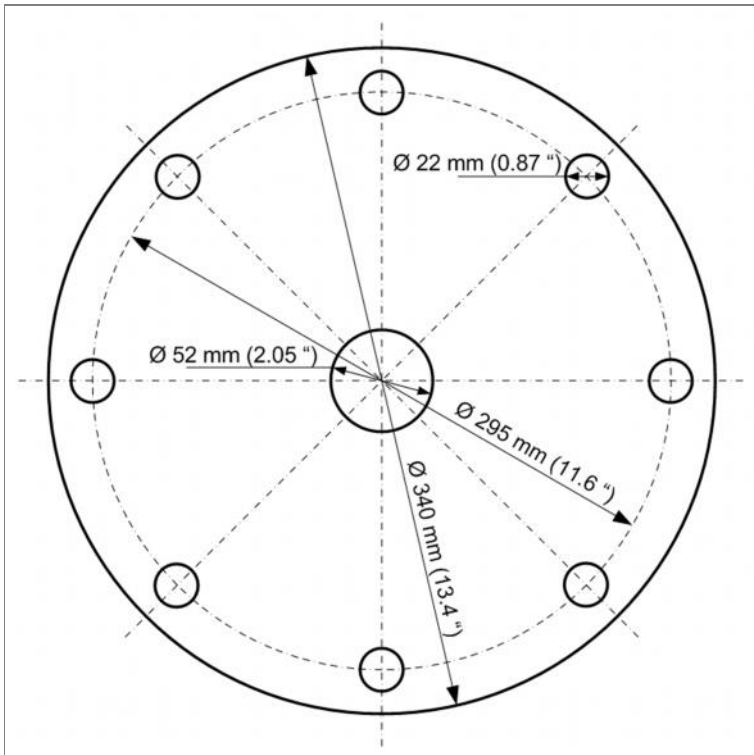

Flange thickness: 6.5mm (0.25").

Flange type DN250

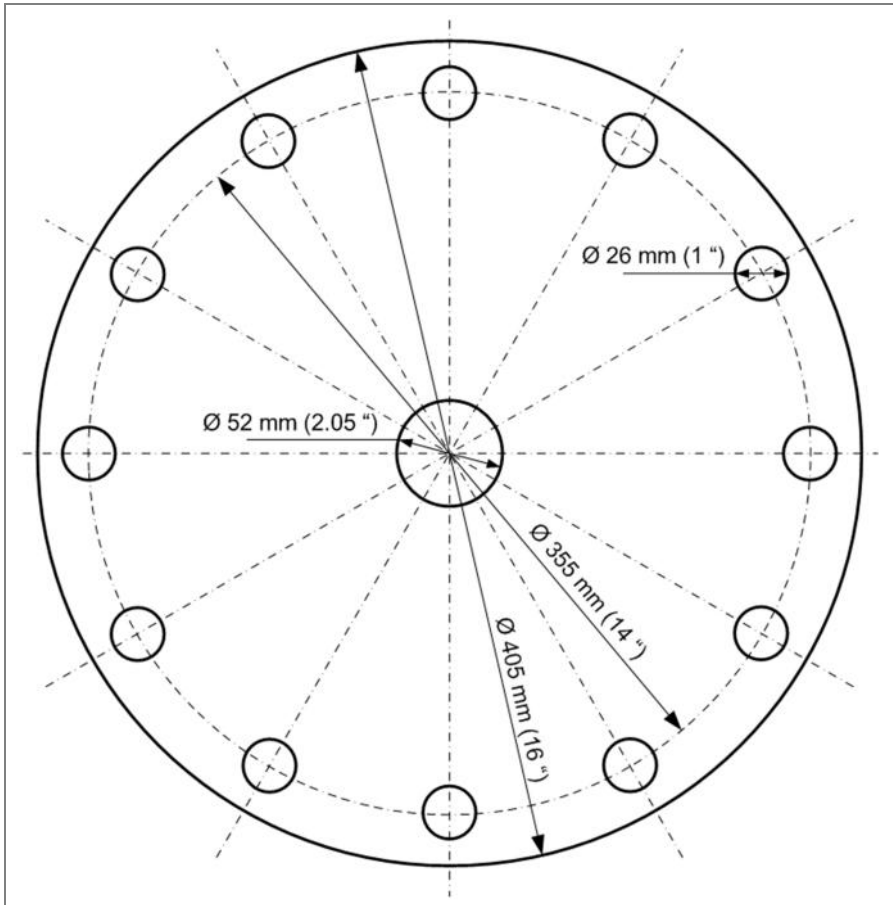

Flange thickness: 6.5mm (0.25").

Flange preparation and installation guidelines

- The transducer case must fit in the hole in the vessel. If this cannot be reached, use alternative solutions such as neck extension or lowering the scanner inside the vessel.
- The widest part of the scanner is the transducers case: 193.3mm (1.61")
- Insert the flange onto the neck tube
- Tighten the nut to the neck thread using an 18" adjustable wrench
- Note: The diameter of the hole in the center of the flange center is 52mm (2.1")

Neck Extensions

The purpose of using the neck extensions is to lower the scanner body below obstructions, such as standpipes, support beams or other construction which might block the acoustic signals.

Neck extensions are available in 2 sizes:

- 30cm (11.81")
- 50cm (19.68")

The neck extension must be purchased with a compatible scanner. An adjusted antennas cable length is manufactured with the scanner and is compatible with the required neck extension.



Note: When using the neck extension, the measurements are referenced to the top part of the scanner body.

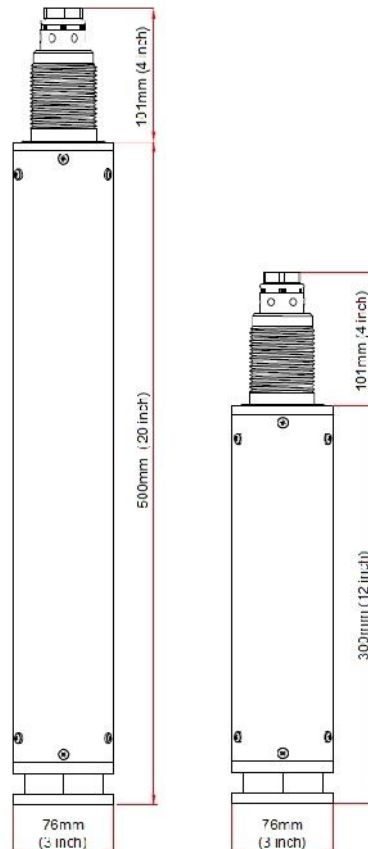

Head-Body separation

The head body separation solution allows installing the body inside the vessel and the head in an external location where it is easy to maintain and reach.

Head-Body Separators are available in 2 sizes:

- 3m (9.85ft)
- 10m (32.8ft)

Head-Body separation dimensions:

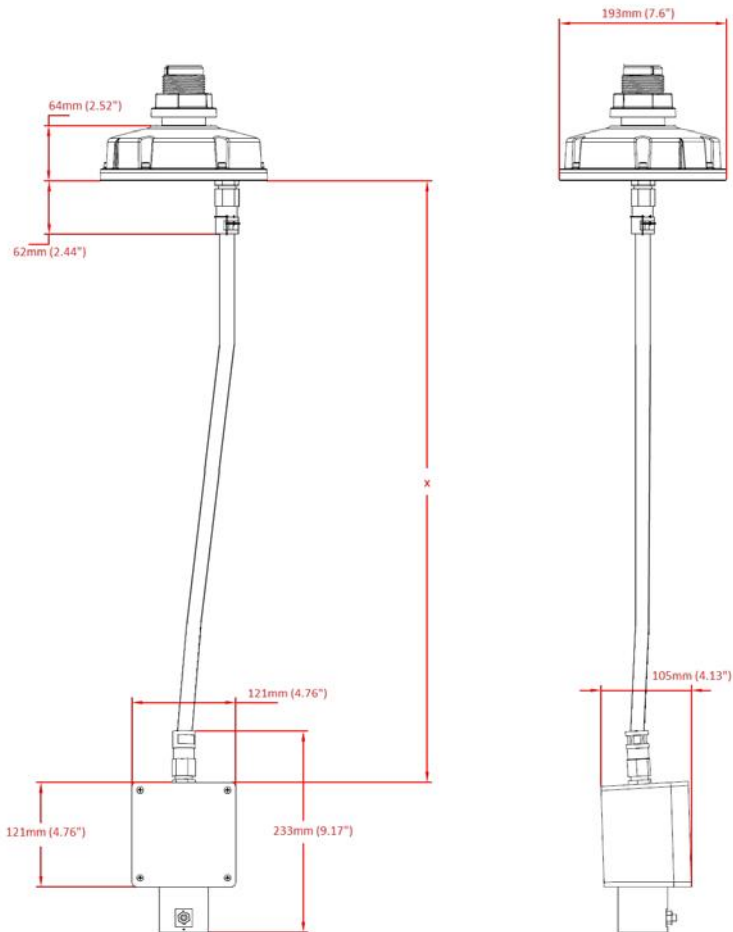

Cable Glands

The 3DLevelScanner™ shipped with one M20 cable gland and one M20 Blind plug.

When ordering 3DLevelScanner with option N under the 'Cable Entry | Plug Connection' section (field V in the Pricelist), it is supplied with accessory kit that includes:

- 1 x M20 Cable Gland
- 2 x NPT ½" adaptor

The provided glands and accessory kit will allow the installer to use any combination as they sees fit.

The available options are:

- Using one Gland and one blind
- Using two glands – unscrew the blind and attached the M20 gland
- Using conduits or ½" glands by unscrewing the existing gland or blind, attaching the NPT ½" and connecting the conduit or gland to the adaptor this can be done using one or both cable entries



M20 Blind Gland



M20 Cable Gland



NPT ½" Adaptor

Appendix C: Maintenance

Preventive maintenance procedure

GTS Recommends the following periodical maintenance procedure for keeping the scanner in proper operating conditions and preventing unnecessary malfunctioning which may be caused by environmental factors during time:

- Clean the interior part of the antennas (see details bellow)
- Visually check and ensure the communication and power cables are in good condition and are not damaged
- Check and ensure proper sealing of cable entry openings
- Open the rear side of the scanner head and ensure absence of wetness

Antenna cleaning guidelines:

- Use a brush or wet cloth for the purpose of cleaning
- Disconnect power to the scanner
- Disassemble the flange and carefully pull out the entire scanner
- As necessary, water can be used for cleaning
- Avoid usage of sharp tools such as screwdrivers for cleaning. Such tools may damage the membranes.

Preventive maintenance frequency

The frequency of the maintenance procedure is subject to the conditions and the type of material stored in the vessel. In the case of materials such as salt, sugar, calcium carbonate etc., treatments should be more frequent.

Appendix D: Recommended Tools

The following tools are recommended for the installation process:

- The site application documents (IPF, AAF), and vessel technical drawings
- A Set of small precision screwdrivers, to be used with the terminal blocks
- 13mm open wrench
- 4mm hex key (preferably with a handle)
- Large adjustable wrench 18"
- Stanley knife, Cutter, Pointed pliers, Isolating tape
- Laser measurement device (or other means to ensure correct positioning and distance to the material)
- RS485 to USB converter, including drivers
- 1200hm (RS485) and 2500hm (HART) resistors
- PC/Laptop
- Internet GSM Stick for testing the communications between the installed scanner and the monitoring computer at the center, using the 3DLinkPro.

Appendix E: Specifications

Technical data

Materials, non-wetted parts

| | |
|------------------------------------|-------------------------------|
| Housing & Antenna | Painted Aluminum die casting |
| Inspection window in housing cover | Polycarbonate |
| Ground terminal | Stainless steel 1.451111.4435 |

Physical

| | |
|--------|--------------------|
| Weight | 5.6kg (12.34 lbs.) |
|--------|--------------------|

Output variables

| | |
|--------------------|--------------------|
| Output signal | 4...20mA |
| Resolution | 10 μ A |
| Current limitation | 22mA |
| Communication | RS485 / ModBus RTU |

Plugs and Cabling

- 1 x cable entry M20x1.5 (cable \varnothing 8...13mm with conductor size of 20 to 24AWG, preferable shielded twisted pairs type cable) assembled on the scanner
- 1 x blind stopper M20x1.5 assembled on the scanner
- Accessory kit with additional M20x1.5 cable gland and 2 x NPT1/2" adaptors

Display panel

| | |
|---------------------|-----------------------------|
| Display | LCD 4 lines x 20 characters |
| Adjustment elements | 4 keys (ESC, +, -, E) |

Load

| | |
|------------------|-------------------------|
| 4-wire sensor | See load diagram bellow |
| Integration time | 0...9999 s, adjustable |

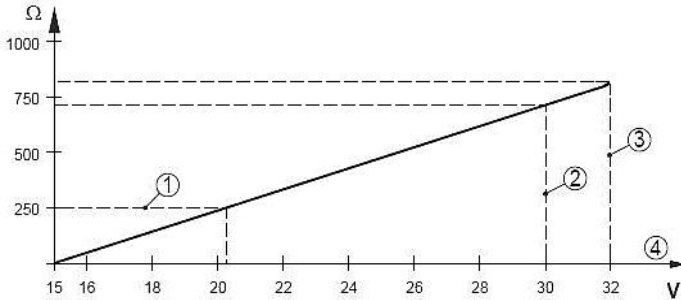

Load Diagram

- 1: HART Load
- 2: Voltage Limit EEx ia device
- 3: Voltage limit non-ExIExd ia device
- 4: Supply Voltage

Ambient conditions

| | |
|--|--|
| Ambient/storage/transport temperature: | -40...850C (-40...+1850F) [3DLevelScanner™ II] |
| | -40...1200C (-40...+2480F) [3DLevelScanner™ II HT] |
| Relative humidity | 20...85% |
| Maximum altitude | 5,000m (16,400ft) |

Process conditions

| | |
|-----------------|---|
| Vessel pressure | -0.5...3bar (-50...300 kPa or -1.25...43.5 Psi) |
|-----------------|---|

Process temperature

| | |
|----------------------------------|--|
| Measured on the process fitting: | -40...850C (-40...+1850F) [3DLevelScanner™ II] |
| | -40...1200C (-40...+2480F) [3DLevelScanner™ II HT] |
| Vibration resistance: | Mechanical vibrations of 2g at 5...200 Hz |

Measurement characteristics

| | |
|------------------------------|--|
| Frequency | 2.65-1 kHz |
| Beam angle with horn antenna | 10 degrees |
| Interval | >2 s (depending on parameter adjustment) |
| Adjustment time | >3 s (depending on parameter adjustment) |

Power supply – 4-wire device

A safety certified power supply which provides double insulation between the primary and output must be used for powering the unit. The power supply must be a limited power source type with maximum output current 1A and voltage range of 20VDC minimum and 32VDC maximum, and not to be connected to a DC distribution network.

Power Supply

The power supply will not connect to a DC distribution network.

Supply voltage 20...32 VDC

Power consumption max 1.5W

Electrical protective measures

Protection IP 61 according to IEC 60529

Approvals

ATEX II 112D, Ex ibD/iaD 20121 T1100C

II 2G Ex ia/ib IIB

cFMus

T4

Intrinsically safe CL I, II, DIV I, GP CDEFG

Comply with the following approval standards:

CAN/CSA C22.2 No. 25, 1966

CAN/CSA C22.2 No. 151, 1992

CAN/CSA C22.2 No. 1010, 2004

CAN/CSA E61241-1-1, 2002

NEPSI

Ex ibD/iaD 20121 T1100C

CE

Ex ia/ib IIB T4

EMC (200411081EC) Emission: EN 61326: 1991 (class B)

Susceptibility: IEC/EN 61326:1991 + A1:1998 + A2:2001 + A3:2003

FCC

NSR (131231EWG) EN 61010-1: 2001

Conformity to part 15 of the FCC regulations

FCC 41 CFR part 15:2001, subpart B, class A

The 3DLevelScanner II complies with Part 15 of the FCC Rules. Operation is subject to the following two conditions: (1) this device may not cause harmful interference, and (2) this device must accept any interference received, including interference that may cause undesired

Dimensions

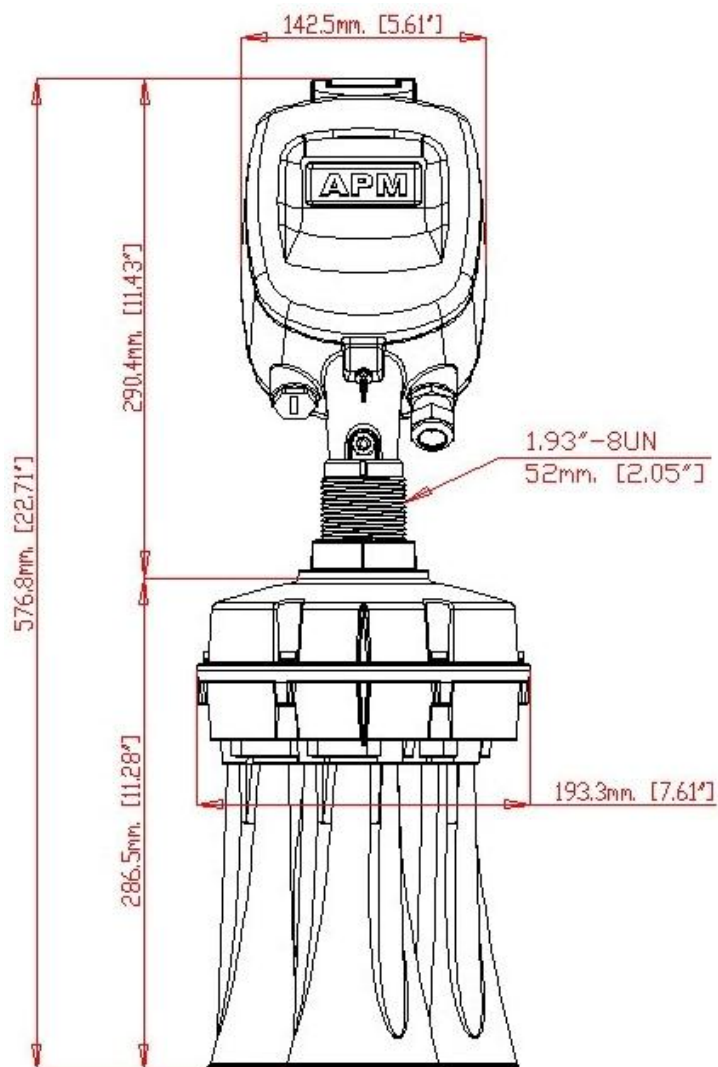

3DLevelScanner dimensions: Front view

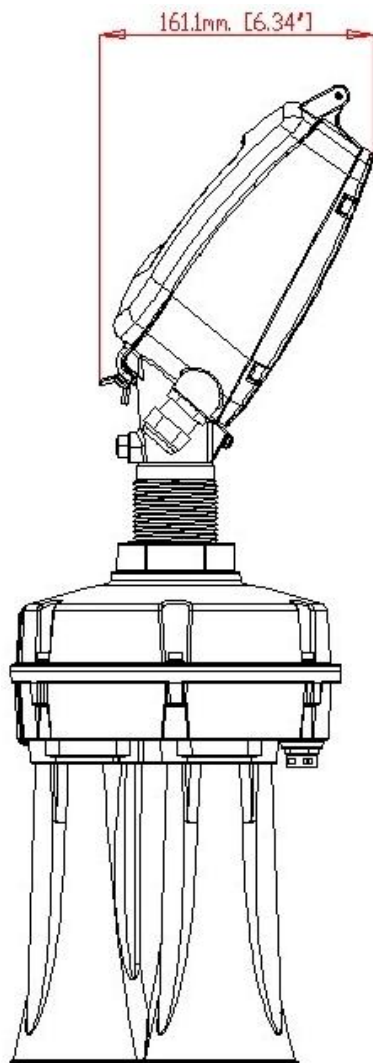

3DLevelScanner dimensions: Side view

Appendix F: RMA Procedure

Return Material Authorization Policy

Overview

This document explains the return policy of GTS Automation Solutions Ltd. It describes the procedures that should be followed to request a Return Material Authorization, how to package and ship the Returned Product, as well as the process from start to finish.

A Customer may request a Return Material Authorization (RMA) by first making a call to technical support and then preparing and submitting proper paperwork.

Glossary

GTS: GTS

RMA: Return Material Authorization

Customer: GTS Authorized Distributor

Return Part / Product: the part or product thought to be defective (initiates the need for an RMA)

Warranty Period

GTS provides a one-year warranty for covered Products and Parts, starting on the date when they are first shipped to the Customer, unless otherwise agreed between the Customer and GTS in the signed distribution agreement.

RMA Request

A request to initiate an RMA procedure must take place prior to returning any Part/Product to GTS. The Customer must start by contacting GTS Technical Support (by phone, email or fax) to obtain approval to report the problem as an RMA. Once GTS confirms that the problem may be reported as an RMA, the Customer needs to fill-in and submit the RMA Form using the link below. GTS will then provide the Customer with an RMA Number to be used on all documentation pertaining to the Product / Part in question.

For tracking and handling purposes, a separate RMA Form must be completed and submitted for each product to be returned. The RMA request must include the product's serial number and a detailed description of the problem encountered. Once an RMA number has been issued, a confirmation by e-mail or fax will be sent to the Customer detailing the RMA number, the Product and Product quantities authorized for return, together with shipping address details and RMA terms and conditions. For both in-warranty and out-of-warranty repairs, the Customer is responsible for paying the outbound freight expense, and any applicable import and/or export duties and taxes. GTS will pay the return freight expense for in-warranty repairs. All Products/Parts returned for repair, both in-warranty and out-of-warranty, should have a label attached detailing the failure/fault/defect and its RMA number.

Note: GTS strongly advises its Customers to hold a small quantity of products in stock for immediate replacement of faulty or damaged units at end-user sites, thereby providing the best service.

Packing and Shipping of Return Products / Parts

It is preferable that original packing, including any anti-static and foam wrapping, be used on all returned products. Should the original product packing not be available, adequate packing should be used taking into account the

method of shipment of the returned product. The Customer is responsible for delivering the returned product to GTS safely and undamaged. The RMA number should be clearly marked on all returned products, boxes, packages and accompanying paperwork. RMA's received by the factory service department that are not clearly marked may experience processing delays.

All Return Products/Parts should be shipped to:

| |
|--|
| GTS, Inc. Attn: RMA# _____ 70 6 th Ave, Shalimar, FL 32579 Phone: 850-651-3388 Email: info@onthelevel.com |
|--|

Discrepancies

Any product received without a proper RMA will be returned to the Customer at the Customer's expense. If any product and/or component(s) of the product listed on the RMA are missing from the box, the Customer will receive notification of the discrepancy and a replacement part will not include the missing component(s). Any unauthorized product included with the RMA shipment may be returned at GTS discretion.

Defect Verification

All Return parts sent to GTS are subject to verification. Product determined to be non-defective will be returned to the Customer as-is. If a product is found to be defective and it is deemed necessary to send the item to the factory for further analysis, please note that they may require up to an additional 21 working days for a final evaluation. In a case where the defect is caused by improper use (not according to the manual) or was damaged intentionally, a repair invoice will be issued to the Customer to approve or leave as-is.

Defect Qualifications

No Return part will be accepted as defective if abused or altered, no matter what the defect is. Products which have been dropped or damaged due to being installed improperly or overpowered will be considered as having been abused by the Customer. Products with customer (or other) markings such as initials or numbers will be accepted only if the product is truly defective and the markings do not interfere with product functionality.

Returning Goods

Following the defect verification, GTS Technical Support will send a report to the Customer describing the fault found and the proposed options at that point.

In case the fault found was due to misuse, whether for a product in-warranty or out-of-warranty, GTS will offer the Customer to fix the Returned Product/Part at the cost as it appears in the pricelist, or alternatively to purchase a new part. The offer to fix the returned part or product is based on the assumption that it can be fixed. The time between accepting the offer to fix the product or part to completion may take up to 4 weeks and this should be considered accordingly. In a case where it is not possible to fix the returned part or product, GTS will offer to sell the Customer a new product in accordance with the pricelist.

Upon completion of the repair, GTS will add the Product to the Customer's next shipment or in any other way per his request and account. GTS will send the Product according to the Customers' directions.

In cases where it is determined that the fault found is GTS responsibility, GTS will try to fix the Returned Product/Part, and if not possible GTS will replace with a new one. In such instances GTS will assume the shipping costs of returning the repaired/replaced goods to the Customer.

Note: RMA Policy, procedure and Forms are subject to change without notice.

Appendix G: Standards & Approvals

3DLevelScanner EMC Test Certificate for FCC Part 15, Sub-part B, Class A

Approved to ISO/IEC 17025



EMC Test Certificate

| | | |
|-----------------------|-------------|----------------------|
| Certificate No | Page | Date of Issue |
| K104551.01 | 1 | 07 April 2011 |



Applicant **APM Automation Solutions Ltd.**
Atidim Hi-Tech Industrial Park, Building 2, P.O.B 58171,
Tel Aviv 61580, Israel



Tested to FCC Part 15, Sub-part B, Class A

Certified Product
E.U.T. 3D LevelScanner II
Model: S*, M**, MV**, MVL**
Serial No.: 25100172
* This model was actually tested.
** See customer's declaration dated 07 April 2011 in ITL test report no. E104551.00.

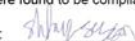
This is to certify that the product specified herein has been tested and the test results were found to be compliant with the requirements noted above.

Signature:  **Signature:** 

Y. Mordukhovitch I. Raz
EMC Test Engineer EMC Laboratory Manager

ITL091 Rev 1.7 26/06/07

I.T.L. (PRODUCT TESTING) Ltd.
PRODUCT SAFETY, EMC & TELECOMS LAB.
Bat-Sheva St., POB 87, LOD 71100 ISRAEL Tel. 972-8-9153100 Fax 972-8-9153101
Email: standard@itl.co.il Web Site: <http://www.itl.co.il>

3DLevelScanner EMC Test Certificate for:

- EN 61326-1: 2006
- CISPR 11: 2003 Class A
- IEC 61000-4-2: 2001 Air Discharge, 8kV
- IEC 61000-4-3: 2002 80-1000MHz, 1V/m; 1.4-2GHz, 1V.m; 2.0-2.1GHz, 1V1m
- IEC 61000-4-4: 2004 Power Lines: 1kV; Signal Lines: 0.SkV
- IEC 61000-4-6: 2004 0.1S-80MHz 1VRMS, 80% A.M. by 1kHz Power & Signal Lines

Approved to ISO/IEC 17025



EMC Test Certificate

| | | |
|-----------------------|-------------|----------------------|
| Certificate No | Page | Date of Issue |
| K104550.01 | 1 | 07 April 2011 |

Applicant **APM Automation Solutions Ltd.**
 Atidim Hi-Tech Industrial Park, Building 2, P.O.B 58171,
 Tel Aviv 61580, Israel



Tested to

| | |
|-------------------------|--|
| EN 61326-1: 2006 | |
| CISPR 11: 2003, Class A | |
| IEC 61000-4-2: 2001 | Air Discharge, 8kV Contact Discharge, 4kV |
| IEC 61000-4-3: 2002 | (80-1000 MHz), 1V/m; (1.4-2 GHz), 1V/m (2.0-2.7 GHz) 1V/m 80% A.M. by 1kHz |
| IEC 61000-4-4: 2004 | Power Lines: 1kV Signal Lines 0.5kV |
| IEC 61000-4-6: 2003 | (0.15-80 MHz) 1VRMS, 80% A.M. by 1kHz Power and Signal Lines |

Note: The above list of tests was performed according to the customer's request.

Certified Product
 E.U.T. 3D LevelScanner II
 Model: S*, M**, MV**, MVL**
 Serial No.: 25100172
 * This model was actually tested.
 ** See customer's declaration dated 07 April 2011 in ITL test report no. E104550.00.

This is to certify that the product specified herein has been tested and the test results were found to be compliant with the requirements noted above.

Signature: *S. Sasson* Signature: *I. Ritz*
 S. Sasson I. Ritz
 EMC Test Engineer EMC Laboratory Manager

ITL091 Rev 1.7 2006/07

I.T.L. (PRODUCT TESTING) Ltd.
PRODUCT SAFETY, EMC & TELECOMS LAB.
 Bat-Sheva St., POB 87 LOD 71100 ISRAEL Tel. 972-8-9153100 Fax. 972-8-9153100
 Email: standard@itl.co.il, Web Site: <http://www.itl.co.il>

3DLevelScanner™ II
3DLevelScanner™ II HT



GTS, Inc.
PO Box 799, Shalimar, FL 32579
Phone: 850-651-3388
Fax: 850-651-4777
Email: info@onthelevel.com
Website: www.onthelevel.com